

# SK<sup>®</sup> 48RE

2003-2008 Diesel & V10

Increases Torque Capacity  
Lockup & Shift Firmness  
Reduces Drainback  
Perfect for Diesel Trucks

48-RE Application

8th vin digit = C 48RE Trans

8th vin digit = 6 47RE Trans

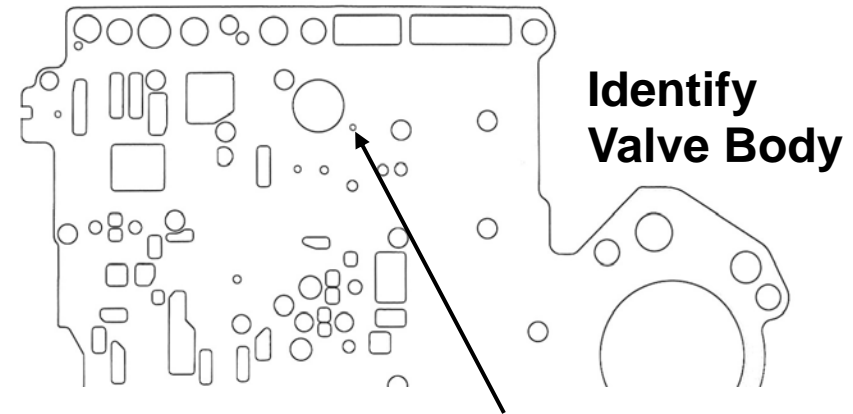

**This kit only fits VB's WITH a balance hole here in the main plate.**  
If your original plate does NOT have this balance hole, USE SK<sup>®</sup>TFOD-Diesel kit.

**This product IS NOT compatible with any 46-47RE Swapped / Hybrid valve body or any previously modified 48RE valve body's from any other sources.**

**1.** If trans is apart, install Seal Rings.

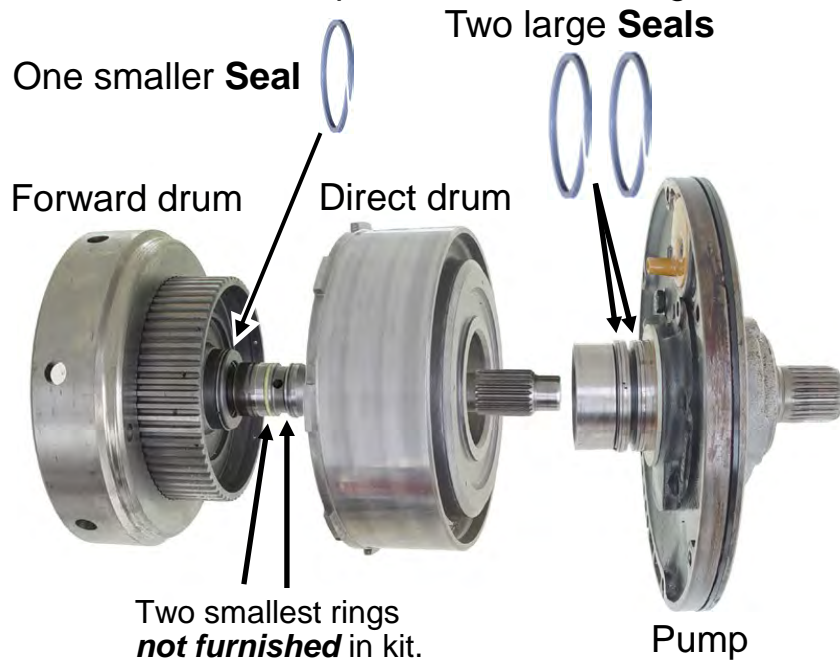

**2.** Install new **PLAIN** lower 1-2 Accum spring as shown. Some models use upper spring reuse it.

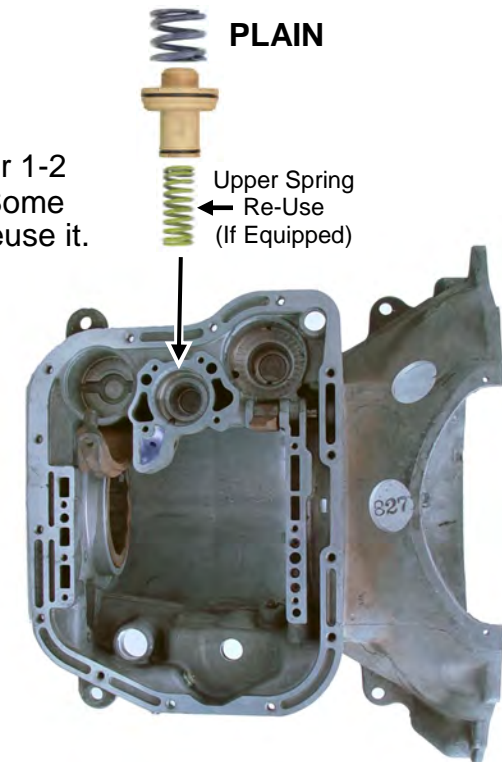

## Good News!

New parts were added in an effort to help reduce governor transducer failures common with this transmission.

# When Installing multi clutch converter SKIP step one.

**1.** Drill one or two .076—.083 holes down through the bottom of the most outboard passage.  
One Hole = Slightly firmer lockup  
Two Holes = Much firmer Lockup



**2. For NORMAL USE skip this step.**  
If later throttle on up-shifts are desired, install new GREEN TV spring. No need to grind TV valve.

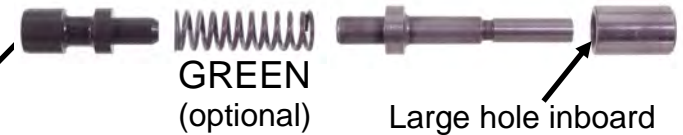

*Got a worn TV valve bore? Order **P/N TF-TV**  
A redesigned TV valve that's a "drop-in" fix.  
No special tools required!*

**3.** Turn the valve body over. Using the edge of a large file, file a notch about *halfway* thru the thickness of this partition.

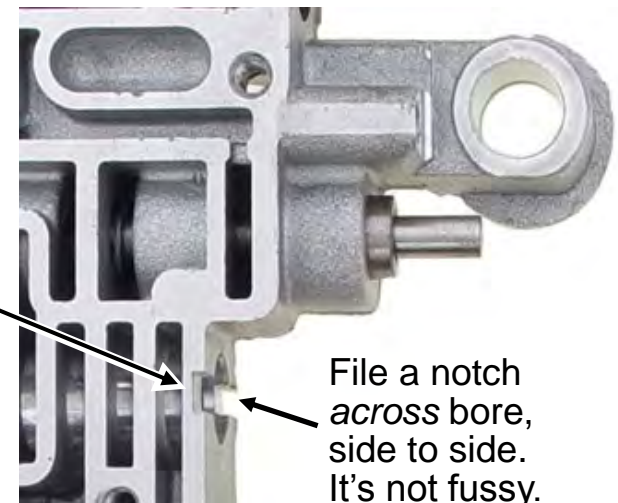

File a notch across bore, side to side. It's not fussy.

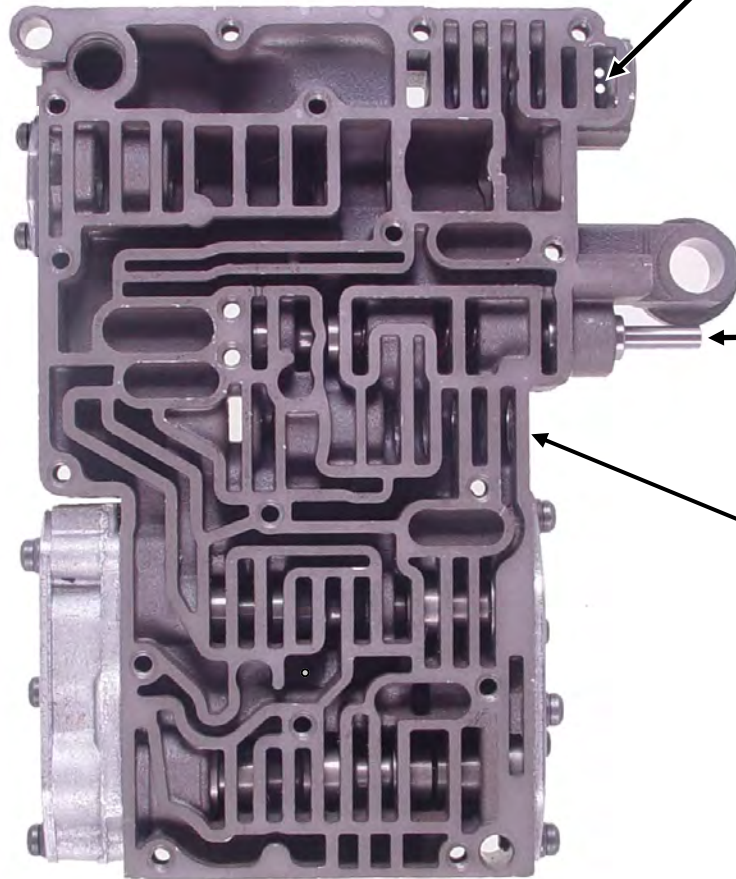

**Watch out for this:**

*Wear in the Boost Valve bore area causes repeated rear band failure & lazy or erratic pressure rise. FIX IT NOW!*

*Order **P/N TF-Boost** Our redesigned boost valve fixes the issue without any special tools required. An easy "drop-in" solution to a high risk failure.*

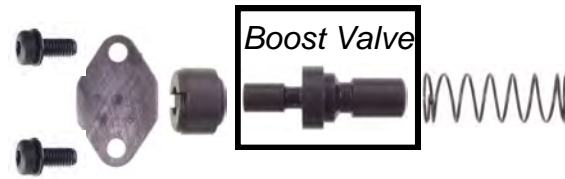

Factory Parts shown for information only.

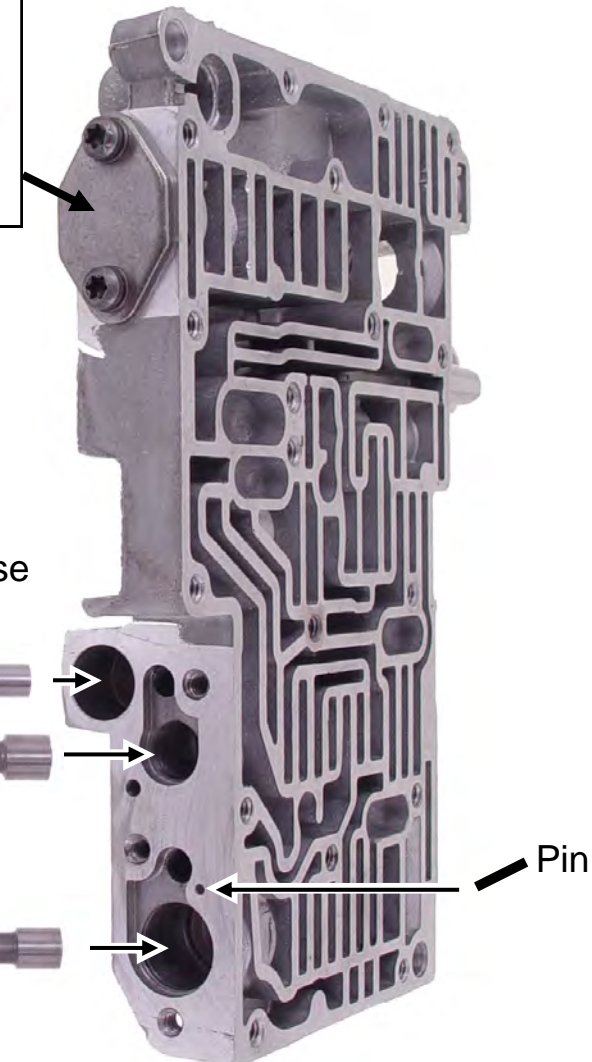

**2.** Install New transfer plate between cover and part throttle body.

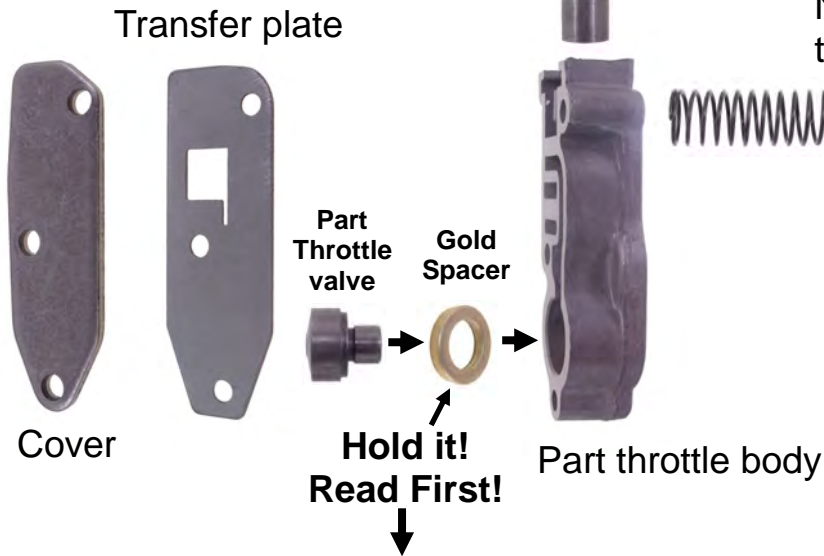

**1.** Install the New **ORANGE** spring here.

No need to remove these three springs & valves.



**3.** For models **WITHOUT** a TV cable (Uses a Throttle Motor) **AND** is equipped with a engine power chip or programmer: Install the gold spacer into the part throttle body. Then install the part throttle (PT) valve. This will reduce the possibility of a **light throttle** 2-3-2-3-2-3 shuttle shift condition. This condition has not been found on TV cable equipped models.

**4.** Use a pick and a small hammer to taper the top of this hole to help start the pin. Install pin furnished into this hole, using needle nose pliers and small hammer. File flush if needed. PT body must sit flush against VB.



**1.** Insert spring and ball into VB pocket. Use the Mumbly Peg to hold the ball in place. Insert new Manual Valve and reassemble the rooster comb. Remove peg.

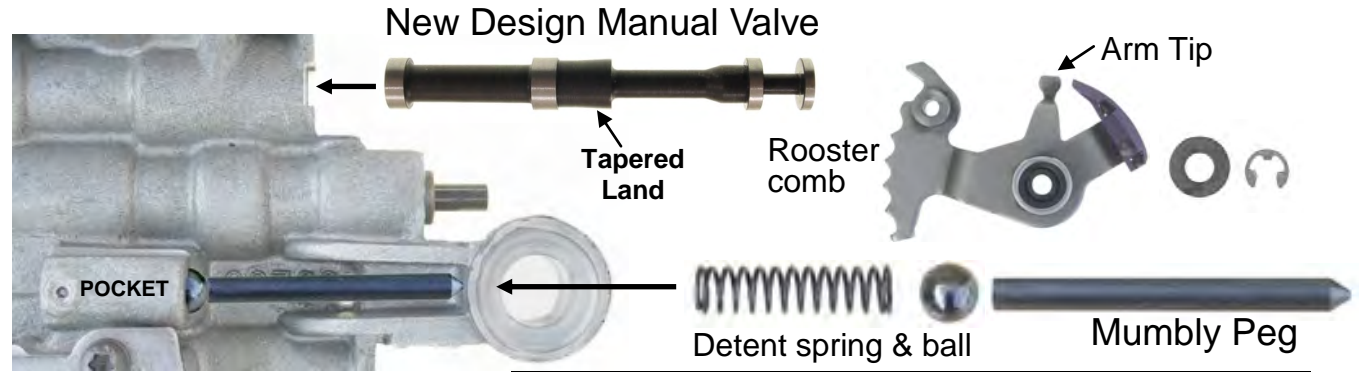

*Detent Ball sloppy in the pocket? Order **P/N TF-Detent**  
New "drop-in" design keeps manual valve indexed correctly!*

**Six Check-balls**  
**One Cherrybomb**

**2.** Install **CHERRYBOMB** here.  
Careful to align stem UP through hole in plate when putting VB together.

- © Five 1/4" (.250)
- © One 11/32" (.343)

**3.** Grind one notch on slight angle to about the middle of this land. Reuse original spring.

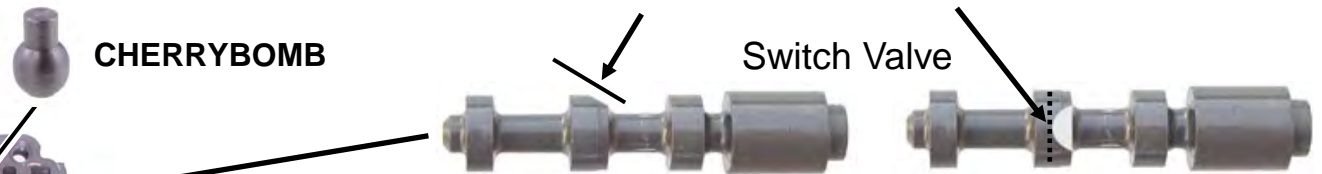

**4. Manual Valve position.**

With valve all the way inboard (Park position) the *right edge* of the Tapered land must be flush with *right edge* of partition "A". (.030" from flush either way is ok.)

**To Adjust:** Bend **Arm tip** with pliers.

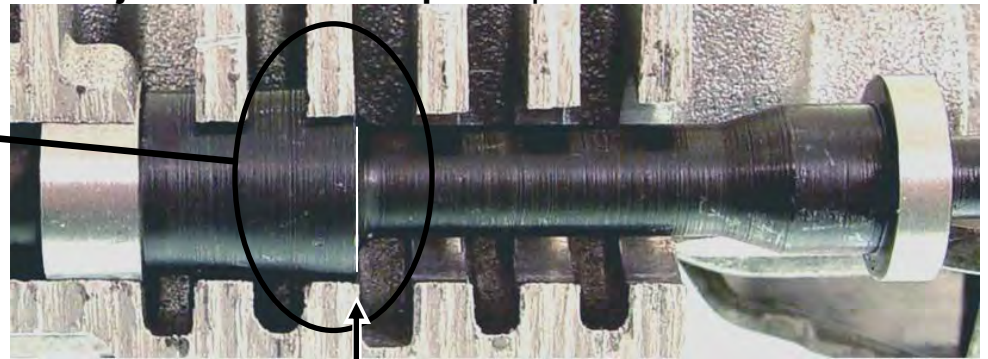
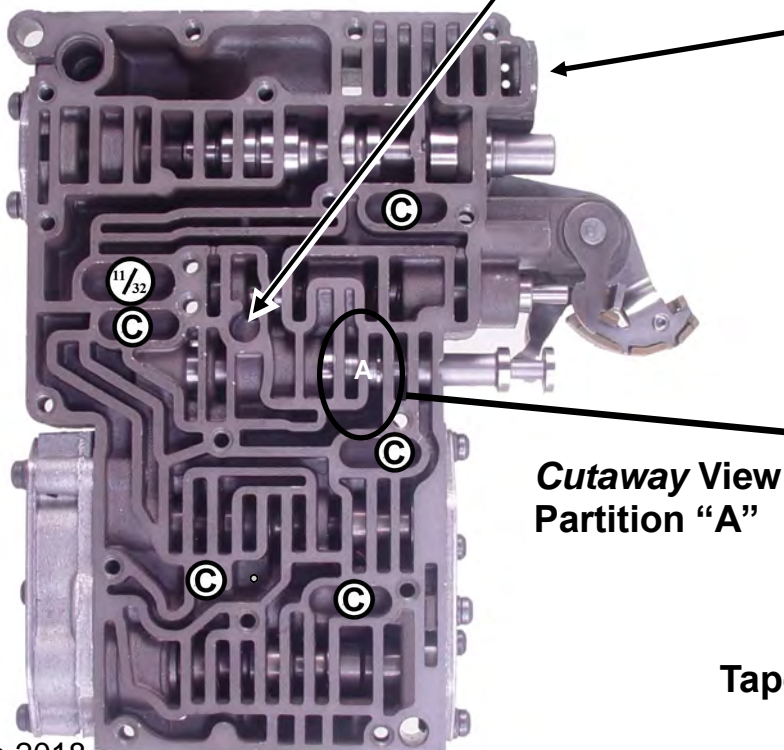

**Tapered Land flush with right edge of Partition "A"**

1. Place .156 drill into hole shown and drill all the way through the accumulator housing. With small punch drive **Plug** into hole just below flush.

2. With small punch drive tapered **PLUG** just below flush into the hole.

3. Install New **Limit Bushing**, **3/16 Ball** and **White** spring as shown.

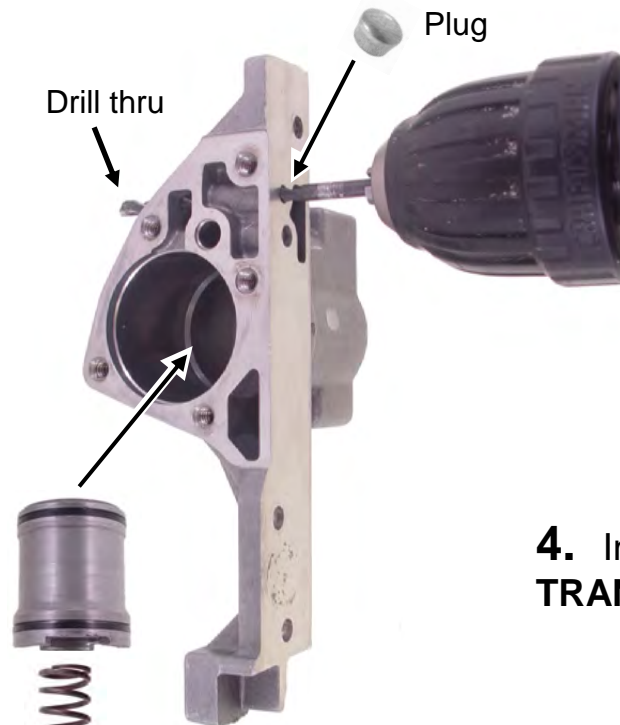

4. Install the new **TRANSFER PLATE**

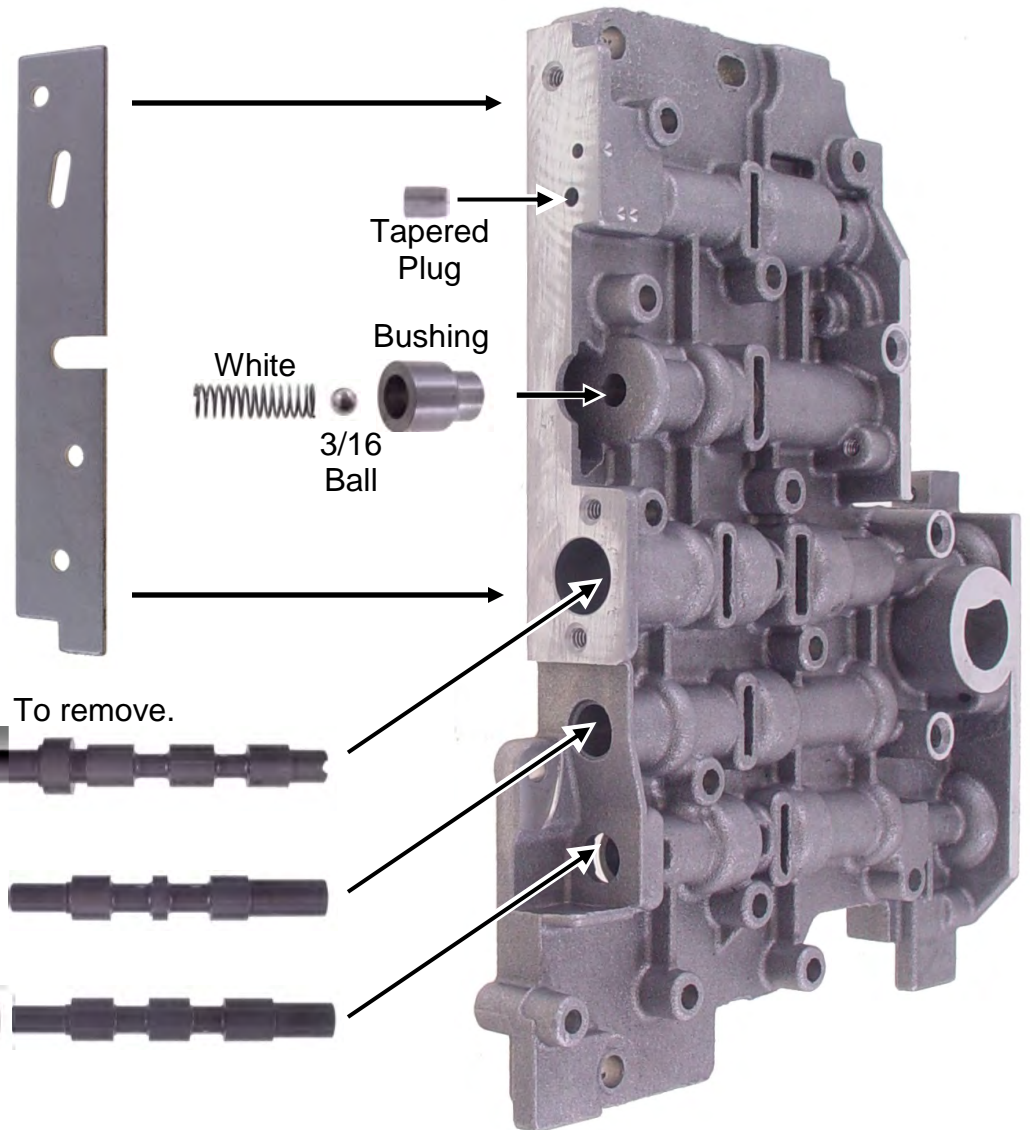

5. Discard original spring  
Install **three** new **Red** Springs.

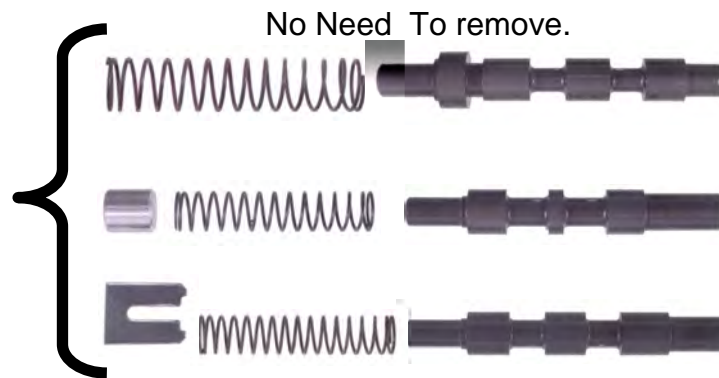



# Lower Body

## Heads Up!

Make sure these small holes are clean or **NO 4th** and/or **NO TCC** will be the result.  
**DO NOT** enlarge these holes!  
 A .020" paper staple fits even in the smaller of the 3 holes & will clean any debris out.

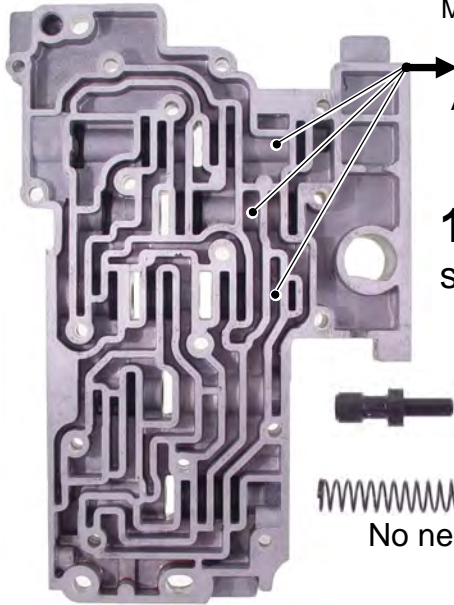

**1.** Install new **ORANGE** spring here.

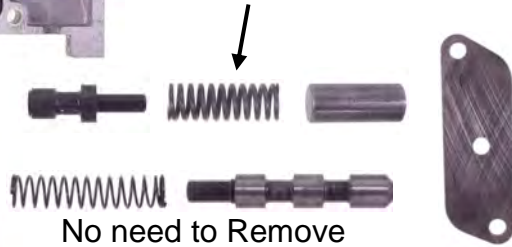

# Lower Plate (Small Plate)

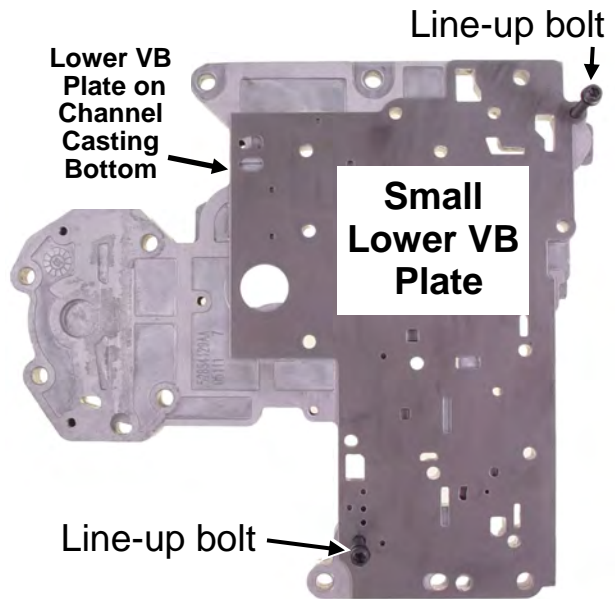

**2.** We need to add a hole to the small **Lower VB Plate**. Use channel casting as drill guide. Place plate on bottom of channel using two VB bolts to line it up as shown, then flip it over.

Use this rectangle passage as guide to drill .103 hole through **lower plate** as shown.



Mr. Shift

Have a great day!

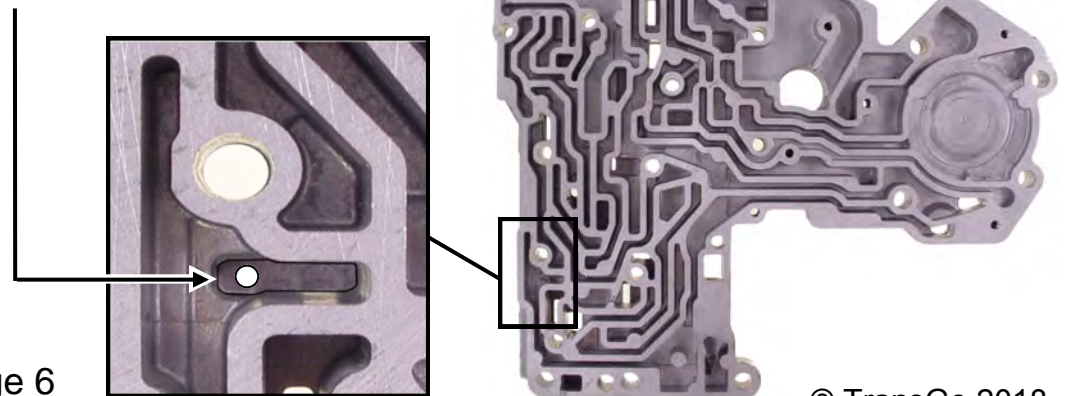

# Valve Body Identification

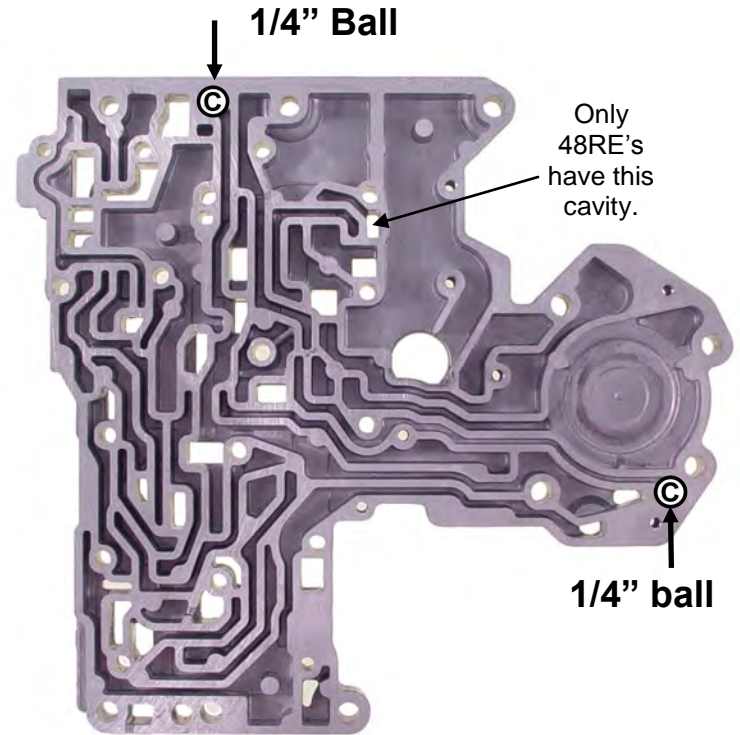
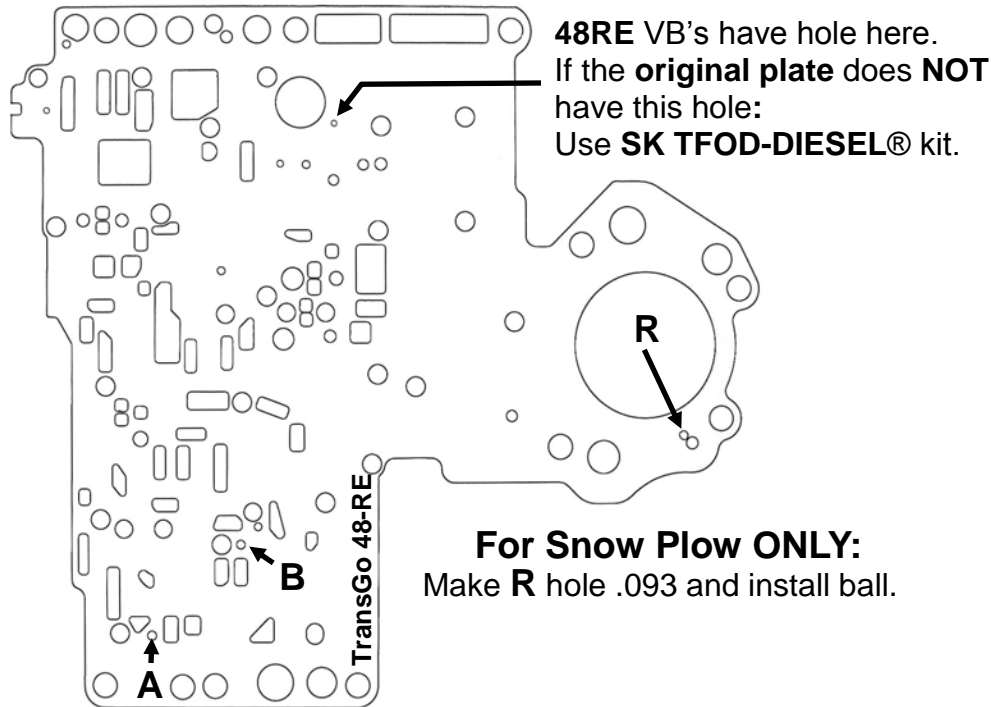

**1.** Enlarge holes A & B with .106 drill. Re-Install original check balls.

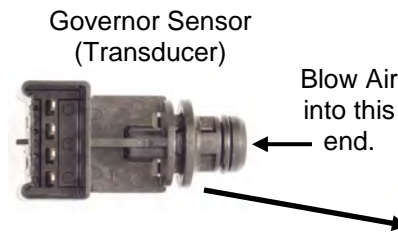

## Pre-testing Governor Sensor

There have been numerous reports of transducers failing shortly after overhaul. Do this simple test to weed out any weak ones. If it passes this test, use it. Using shop air (120-130 psi max.) blow air into the end of the transducer. Use a rubber tip blow gun, make a good seal and listen. IT MUST NOT LEAK.

**2.** Install new plate against channel casting then gasket and solenoid body.

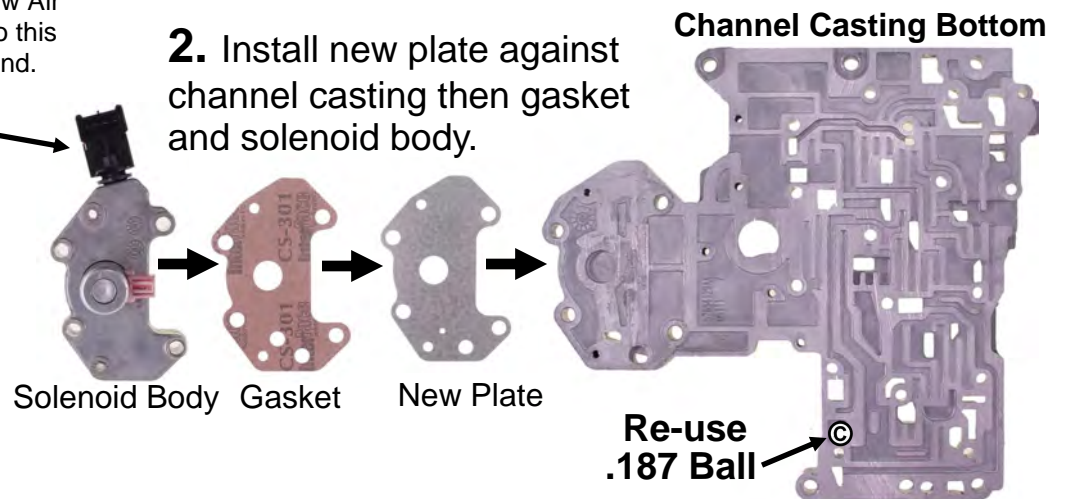



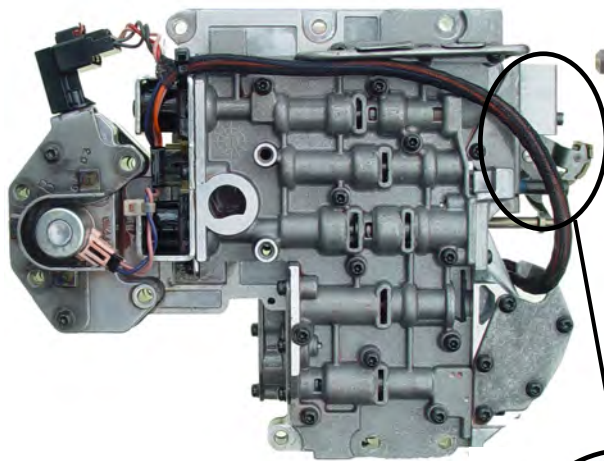

**Fluid level checking:** While the new manual valve provides oil to the converter in park, **DO** check fluid level in **Neutral** for accuracy as the converter is charged **MORE** in neutral.

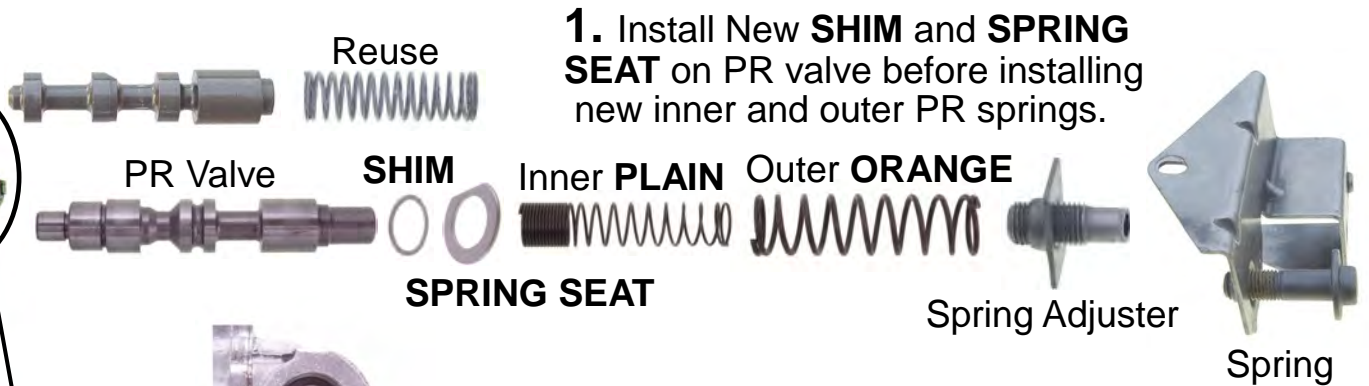
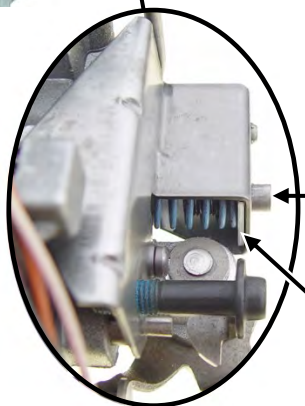

**1. Install New SHIM and SPRING SEAT** on PR valve before installing new inner and outer PR springs.

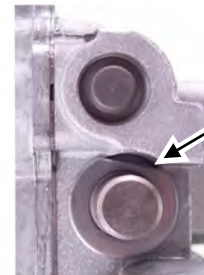

Install Spring Seat as shown. Make sure flat on spring seat has some clearance from casting. File casting if necessary to give it a little room to rotate slightly. Do not allow it to bind between PR valve and casting! Recheck this *just before* installing VB into case.

**2. PR Spring Adjustment**

With 3/16" allen wrench, turn adjusting screw *clockwise* until spring adjuster is just *flush* against the inside edge of spring retainer.

Flush Here

**3. Install the new Lockup Bracket**

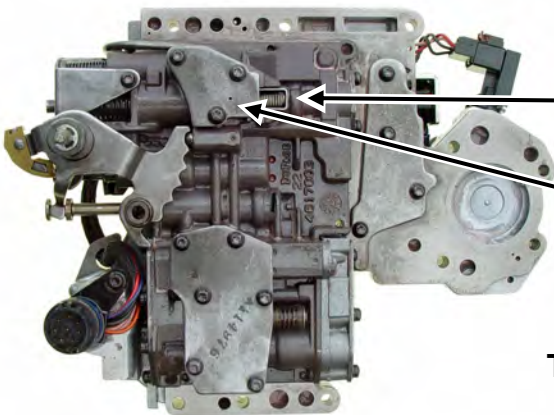

**New Boost Tuning Plate (Optional)**

Re-Use Original Plate.  
Stock plate hole sizes vary.

**Optional: New Boost Tuning Plate**

Factory 48RE Boost hole size in the original plate ranged from .052 to .073 and is plenty. Bigger hole = More Pressure

*Is the hole already drilled too BIG? (Leads to rough 3-4 or TCC Apply)*

New tuning plate lets you start over. Drill to desired size from the range above and install **UNDER** the original plate, being sure to line up the hole in **both** plates as you tighten the retaining screws.

**Tech Tip:** Using a triple disc converter in a stock daily driver can lead to rough 3-4 and/or rough TCC complaints from your customers.