



# TF-3 *Stick Shift*

This is not a "do it yourself" kit.

It is for the Experienced, Professional Trans Mechanic only.

## REPROGRAMMING KIT™

### Full Manual Control Torqueflite 3 Speed

Fits 66up Alum Torqueflite EXCEPT Models With Lockup Converter \*See page 6

Does NOT fit 60-65 models with Rear Pump!

1. Remove E-clip & washer. Remove rooster comb, being careful to catch ball & spring. Discard original manual valve.

2. Turn the valve body over. Using the edge of a large file, file a notch about *halfway* thru the thickness of this partition.

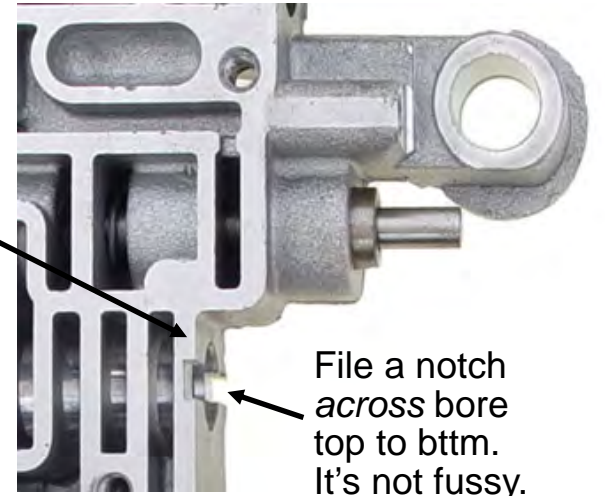

3. Insert spring and ball into VB pocket using the **Mumbly Peg** to hold the ball in place. Insert new **Manual Valve** and reassemble the rooster comb. Remove peg.

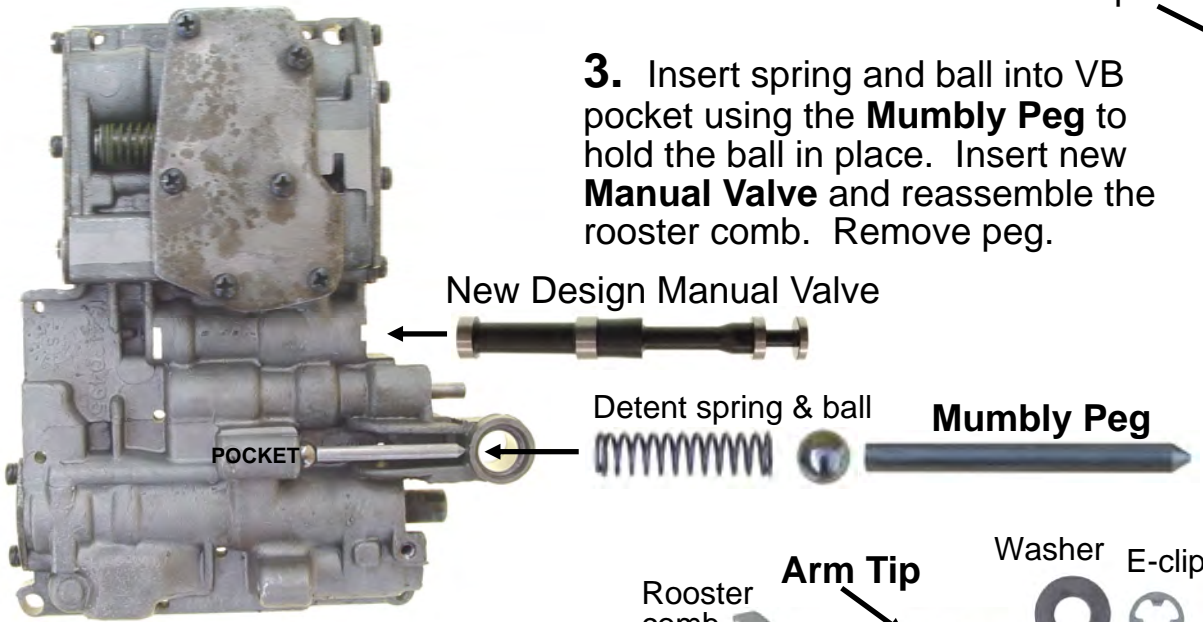

#### 4. Manual Valve position.

With valve all the way inboard (Park position) the *right edge* of the tapered land must *be flush* with the right edge of partition "A". (.030" from flush either way is ok.)

**Adjust:** Bend **Arm Tip** with pliers.

**Tapered Land flush with right edge of Partition "A"**

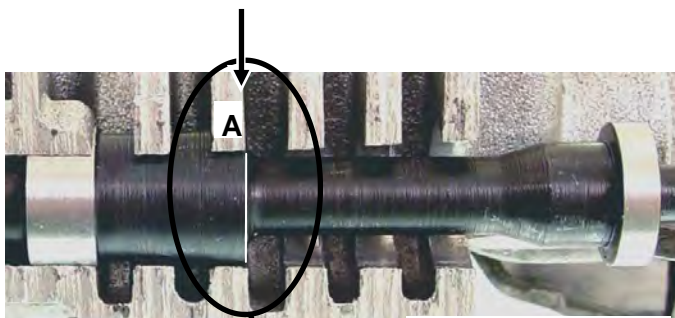

**Cutaway View Partition "A"**

5. At prox angle, using .046 drill furnished, drill a hole from right to left **thru** this partition under "X".

6. If VB has barrier here drill .125 hole thru it.

7. Grind **stem end** of the TV valve using the picture as a guide, leaving a stem length of prox 9/32" (.281).

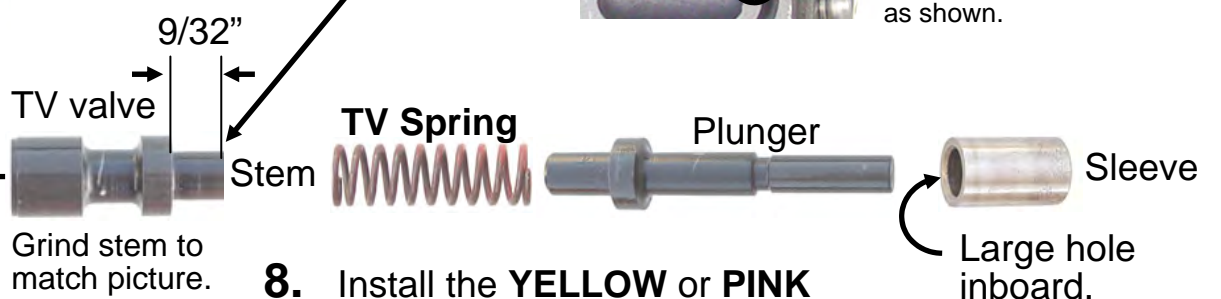

8. Install the **YELLOW** or **PINK** TV spring that is same diameter as original spring.



**1.** If VB **HAS** line bypass ball & spring, drill 3/16" hole into spring pocket thru VB casting under "X". De-burr hole inside. Install **WHITE** spring and .375 steel ball.

.375 (3/8") steel ball

**WHITE**

Spring pocket

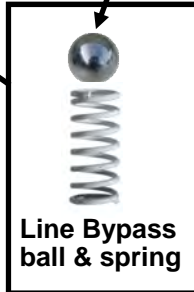
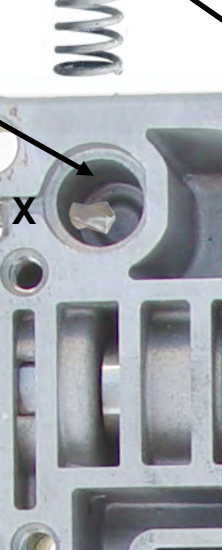

Line Bypass ball & spring

**LISTEN UP -- Bypass location RULE:**  
**NO Hole L** in Plate, nothing goes here! Skip Step 1.  
 Has **Hole L**? Install new white spring and .375 Ball.  
 (See Plate **Page 3**)

**Checkball Usage**

- Ⓒ 1/4" (.250)
- Ⓜ 11/32" (.343)  
Some models use 5/16" (.312)
- ⓧ 1/4" (.250) some models
- Ⓜ Leave this ball out

7/16" Match drill to picture.

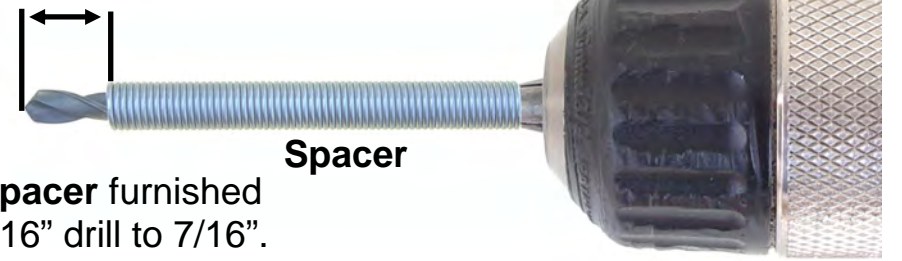

Spacer

**2.** Using **Spacer** furnished adjust 3/16" drill to 7/16".

**3.** Install **Drill Plate** on VB *this side up*.

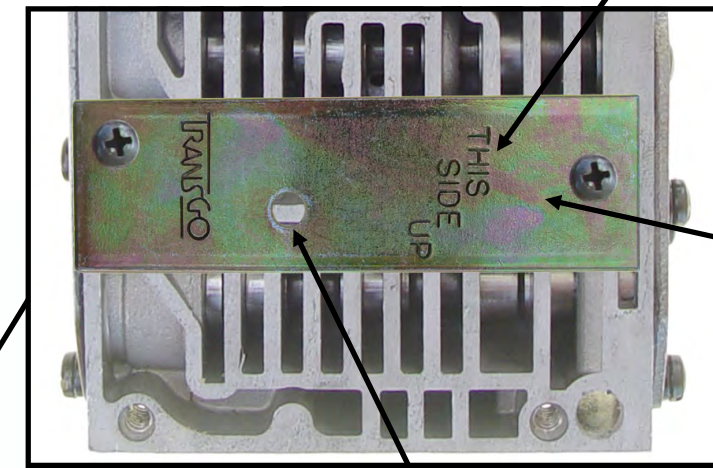

Drill Plate

**4.** Using **Spacer** as a stop, drill straight down into this hole with the 3/16" drill.

**5.** Grind 1-2 Governor Valve as shown below. It gets **hot** so have a dish of water handy. Grind land "B" to prox diameter of land "A". Grind land "C" 3/32" to 1/8" wide.

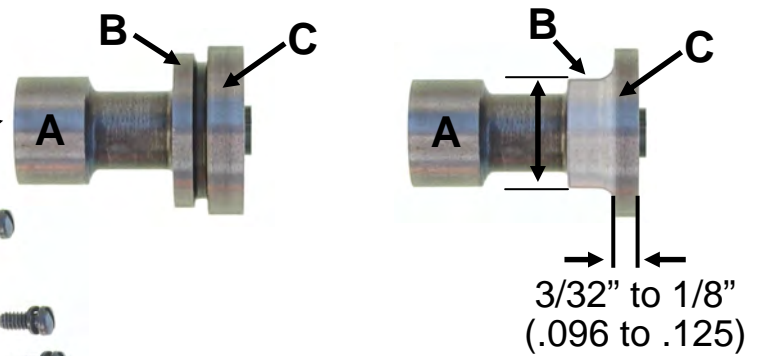

3-2 Downshift assembly not used on all models.

No need to take apart.

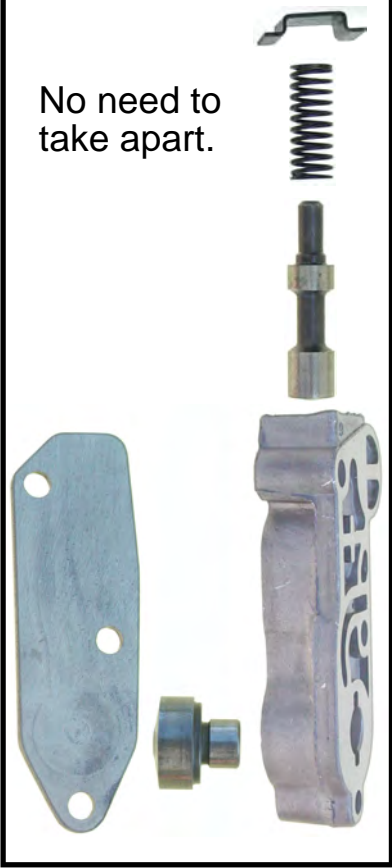

**6.** Remove original 1-2 shift valve spring. Install the **ORANGE** spring.

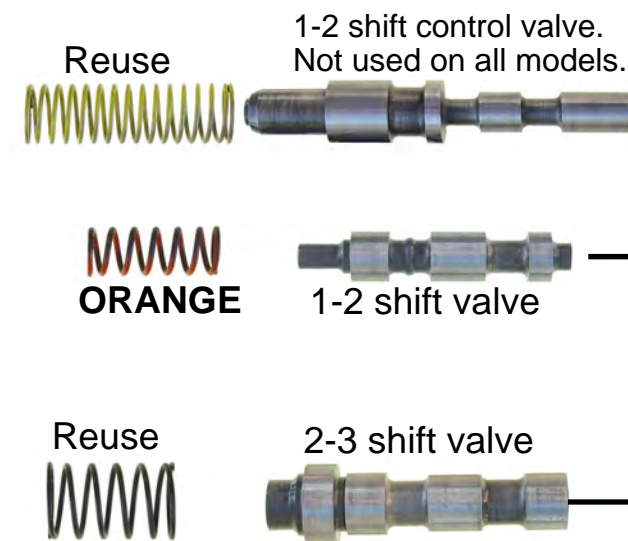

Reuse

**ORANGE**

Reuse

1-2 shift control valve. Not used on all models.

1-2 shift valve

2-3 shift valve

1-2 Gov valve

Shuttle spring & plug

2-3 Gov plug

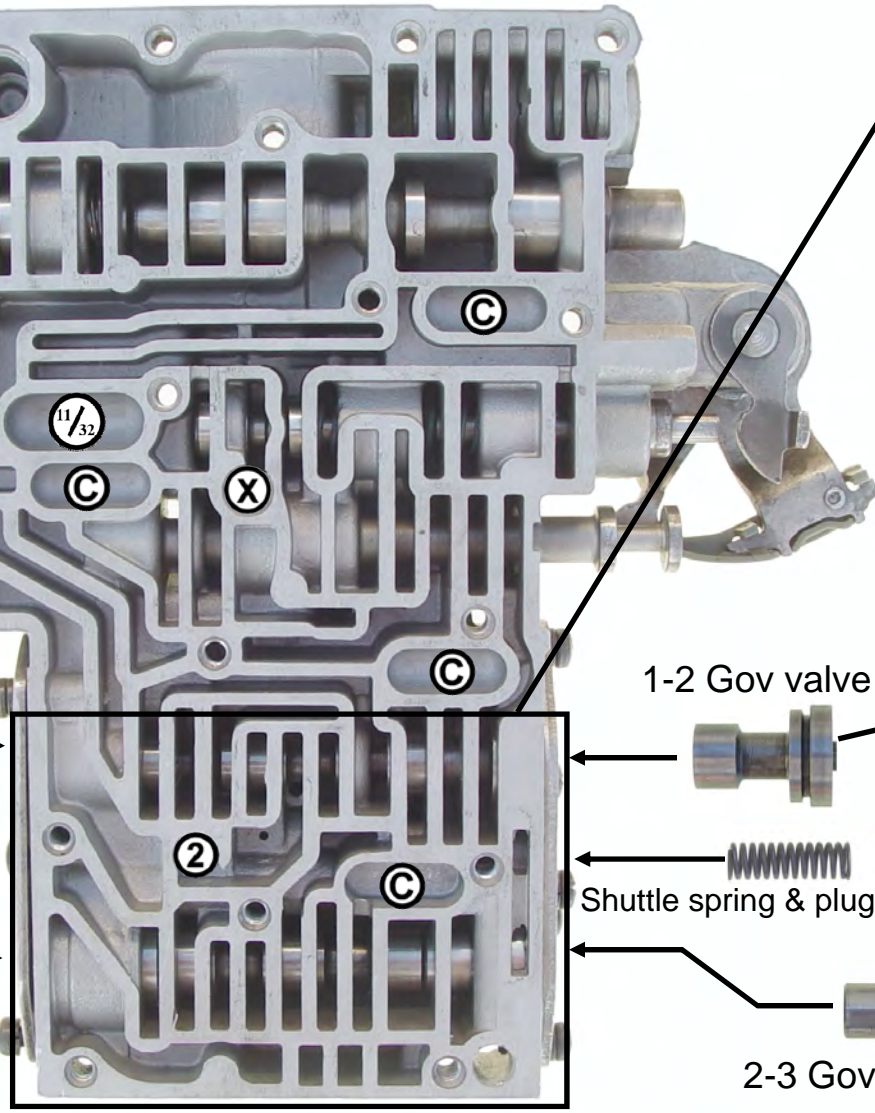



# Separator Plate

If plate has hole "L" valve body must have 3/8" steel ball and spring. See **Page 2**.

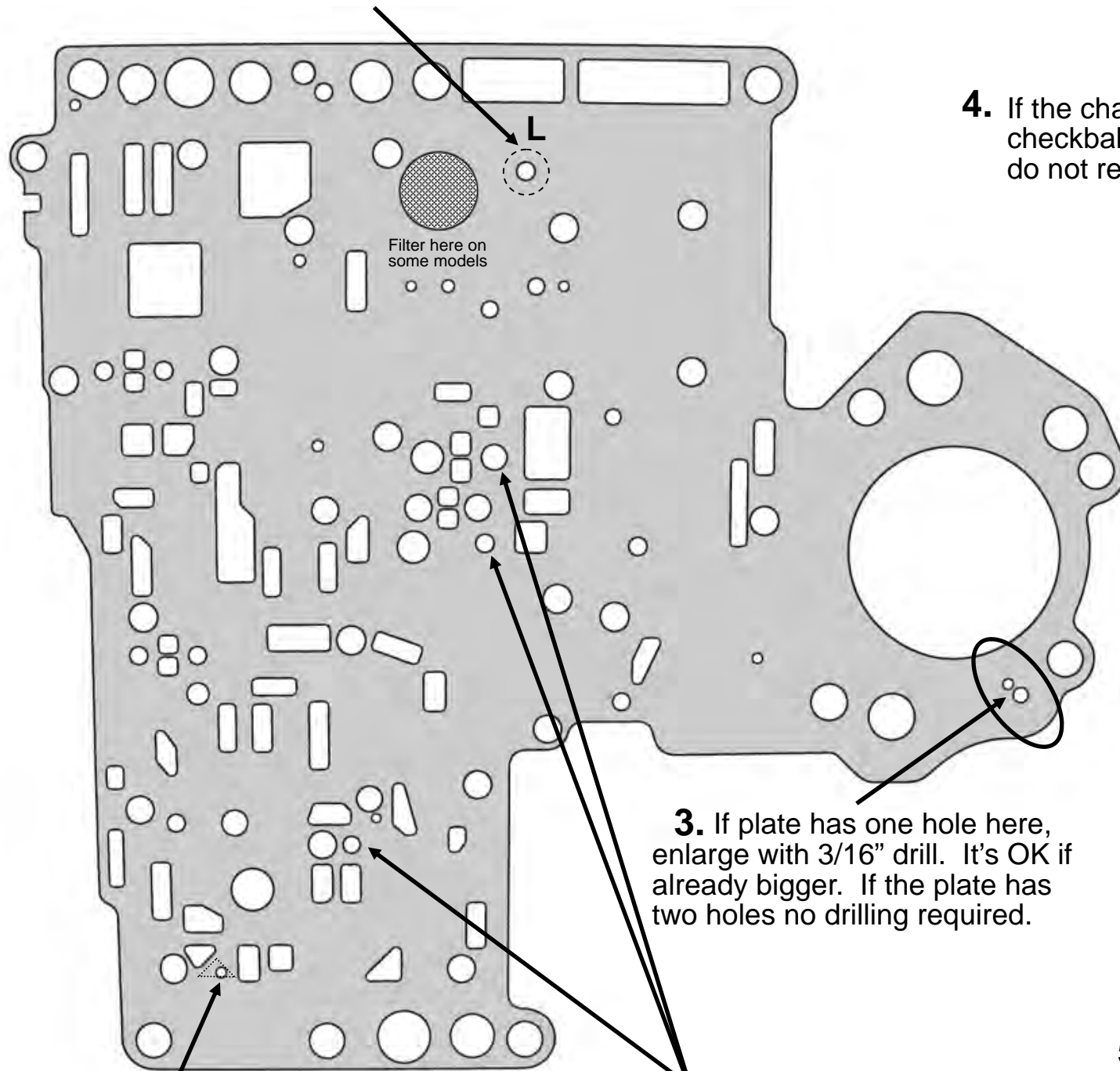

**1.** Enlarge this hole with 3/16" drill furnished. If the hole is triangle shaped no need to drill.

**2.** Enlarge these three holes with 3/16" drill. OK if already bigger.

**3.** If plate has one hole here, enlarge with 3/16" drill. It's OK if already bigger. If the plate has two holes no drilling required.

**LISTEN UP:** After drilling the holes from *this side of plate*, by **hand** turn 3/8" or larger drill to chamfer holes **SLIGHTLY** to remove burrs.

# Channel Casting

**4.** If the channel casting has checkballs, either location, do not reinstall them.

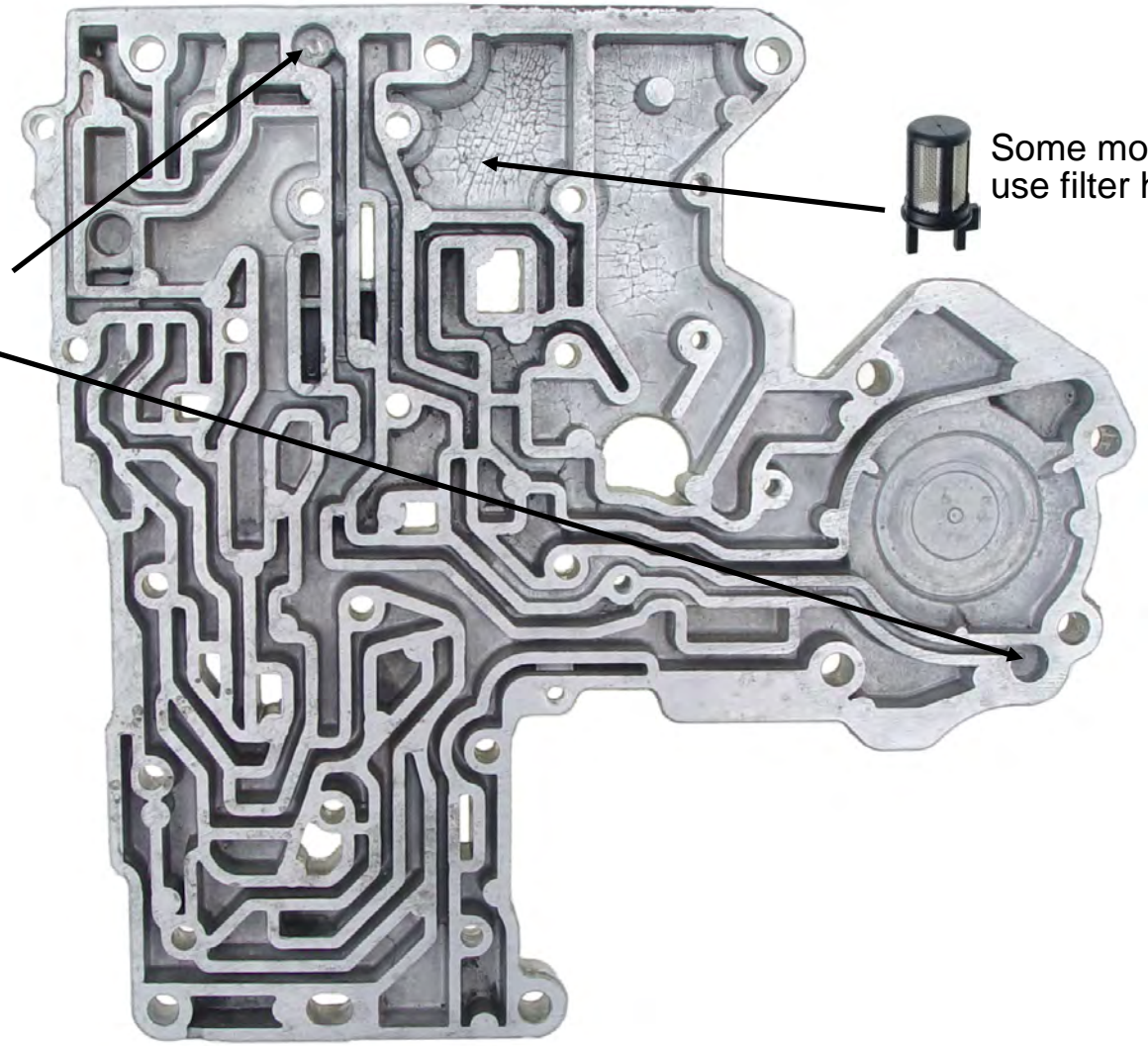

**Transfer Plate**

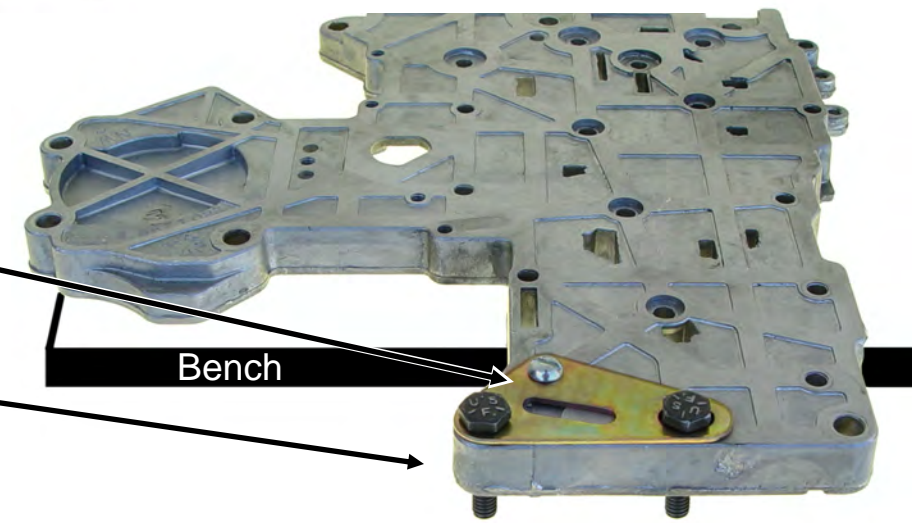

**5.** Place channel casting on bench with this end hanging over edge slightly. Place **Transfer Plate** on casting using two VB bolts and one screw thru the holes to locate it.

With 3/16" drill furnished, drill two holes straight down thru casting, One at each end of transfer slot.

Remove bolts and plate, debur holes.

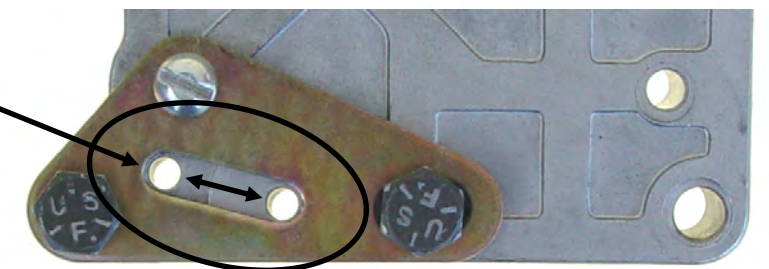



**Fluid level checking:** While the new manual valve provides oil to the converter in park, **DO** check fluid level in **Neutral** for accuracy as the converter is charged **MORE** in neutral.

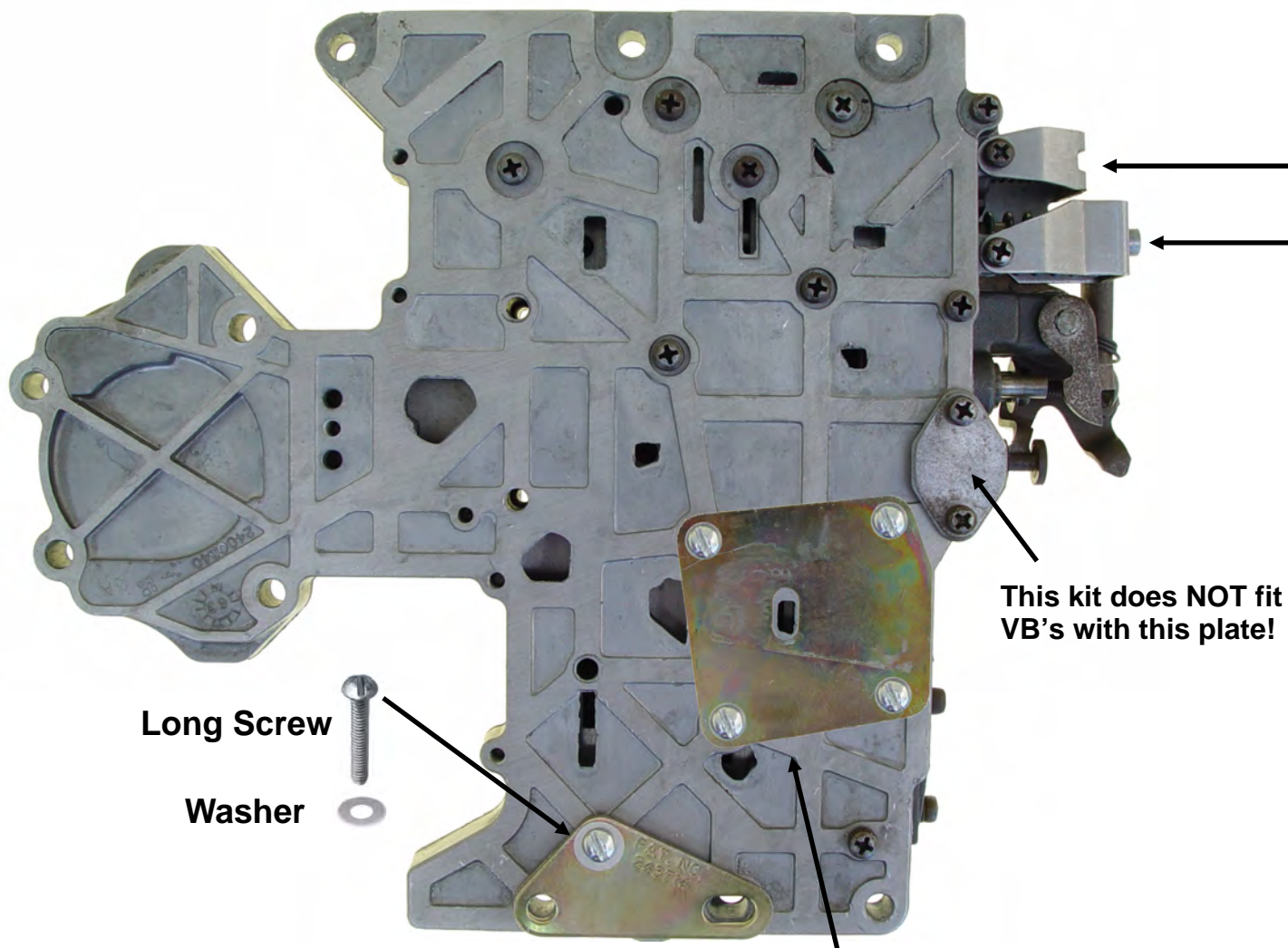

Long Screw  
Washer

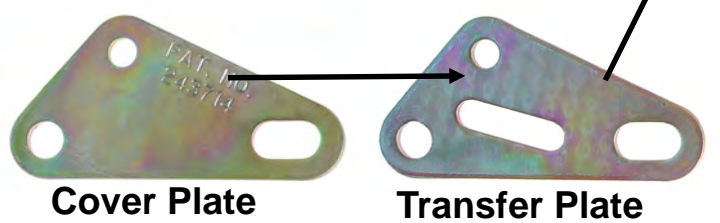

**5.** Place **Transfer Plate** onto channel casting *first*. Then install **Cover Plate**, with **Long Screw & Washer** furnished.

**4.** Install **Shift Command Plate** with four **Long Screws** furnished.

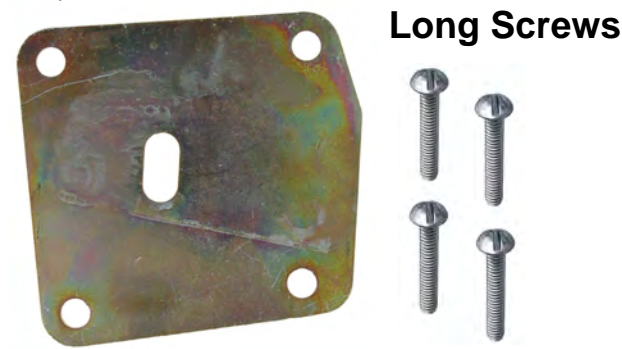

Shift Command Plate

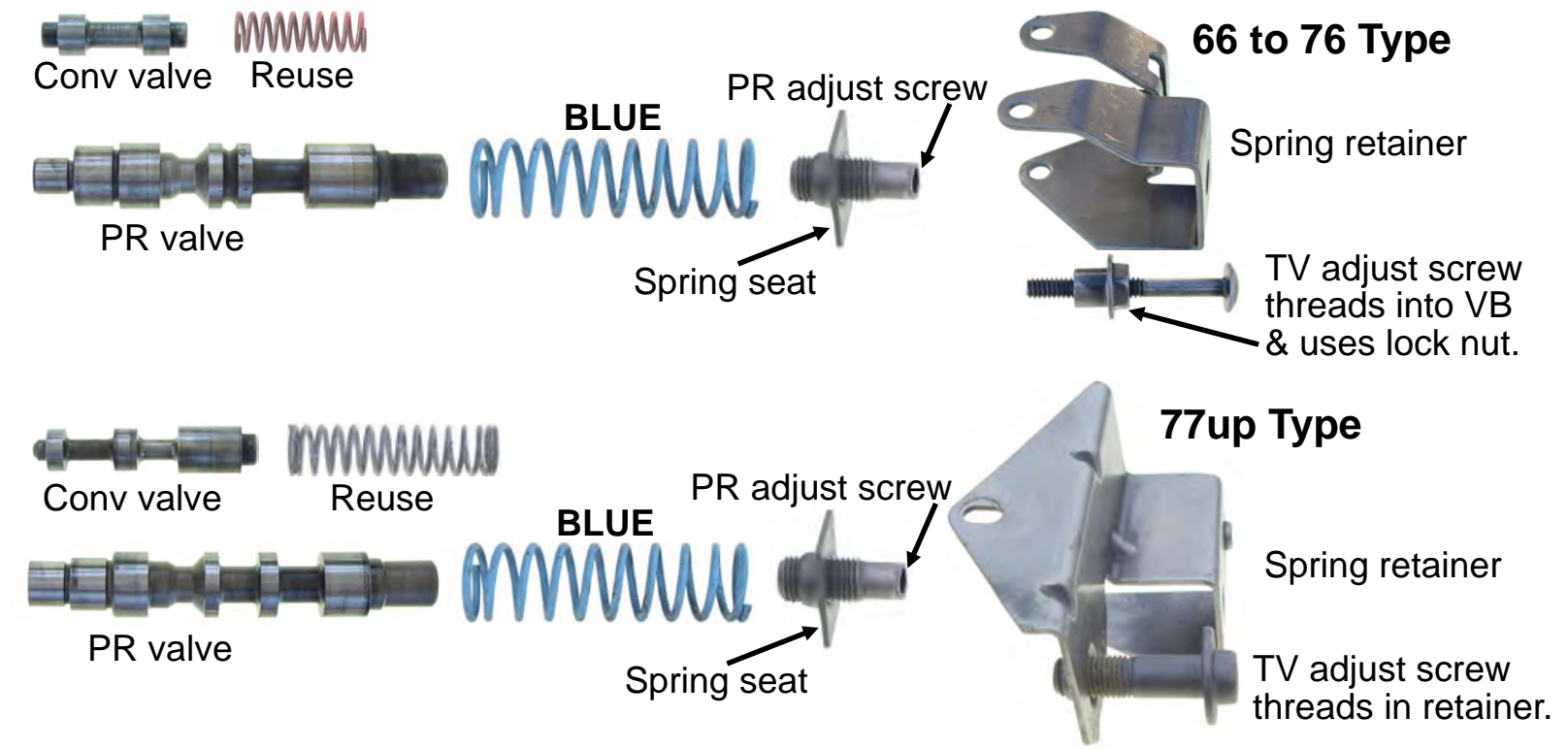

**1.** Install the Conv Valve with original spring. Install PR Valve with **BLUE** spring furnished.

**2. LISTEN UP: PR Adjustment is Important!**

With 3/16" allen wrench, turn **PR adjust screw** *clockwise* until spring seat is just *flush* against the inside edge of the spring retainer.

**Street/Strip & Off Road Use:** Leave flush  
**Trailered Competition Race Car ONLY :** Adjust screw *counter-clockwise*, no more than four (4) turns from *flush*.

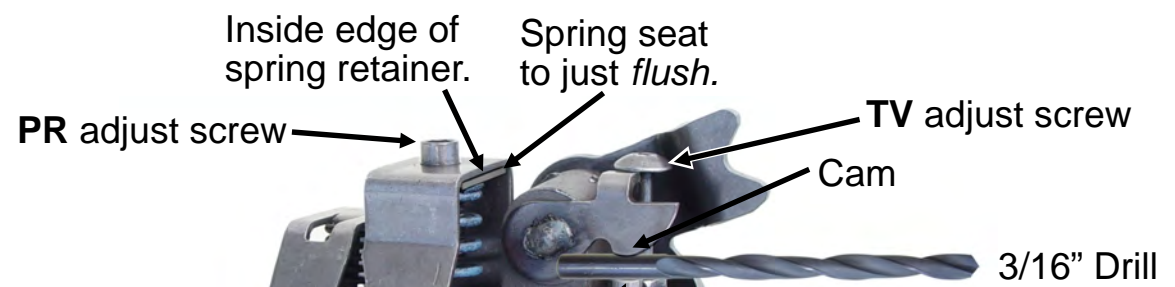

**3. TV Adjustment**  
 Tighten **TV Adjust Screw** until the 3/16" drill will pass freely between **Cam** and **TV Plunger**. Tighten lock nut if used.



## Step 1. L/R Piston-- 904 & 727

**904 Trans:** Don't disassemble L/R piston. Reinstall L/R piston into case with **Short PLAIN** spring. If spring won't fit retainer or into piston reuse the original spring.

**727 Type 1:** Remove cushion spring, reassemble piston. Install the L/R piston into the case with the **Short PLAIN** spring. If spring won't fit retainer or into piston reuse the original spring.

**727 Type 2:** Install **Spacer**, reassemble the piston. Install L/R piston into case with **Long PLAIN** spring.

### 727 (Type 2) L/R Piston Binding/Cocking

Grind land inboard of lip seal groove about halfway to the piston shoulder. This prevents lip seal from being pinched and binding piston in the bore. **Don't worry, it's OK.** This tech's been around over forty years, been done thousands of times, and still works great today. Gil.

### 904 All Types

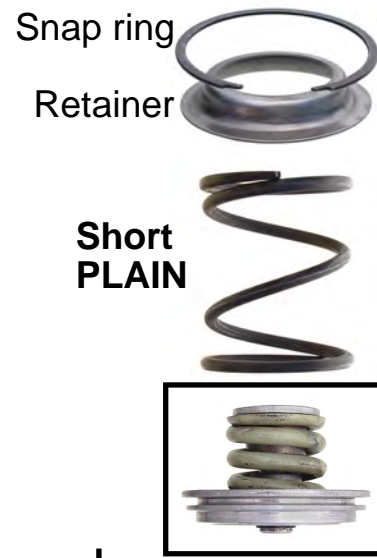

Don't take apart

### 727 Type 1



Remove cushion spring

### 727 Type 2

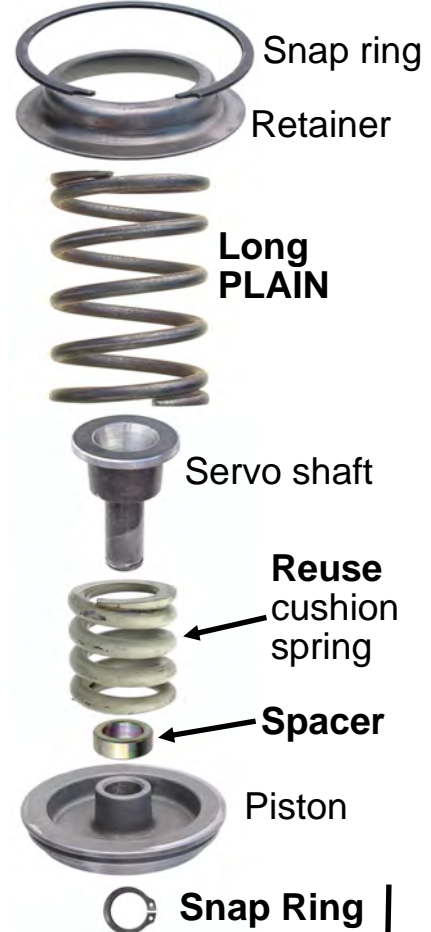

Long PLAIN

Reuse cushion spring

Spacer

Piston

Snap Ring

### Accum Piston & Spring(s)

Accum piston spring(s) might be on the top, bottom, both or none at all. Reinstall as it came apart.



**Step 2.** With 5/16" punch or bolt, install the **Solid Cup Plug (NO Hole)** into the case.

Solid Cup Plug

NO HOLE

**Step 2. 727 models only!**

With 5/16" punch or bolt, install the **Orifice Plug** into this hole in case.

Orifice Cup Plug

Has Hole

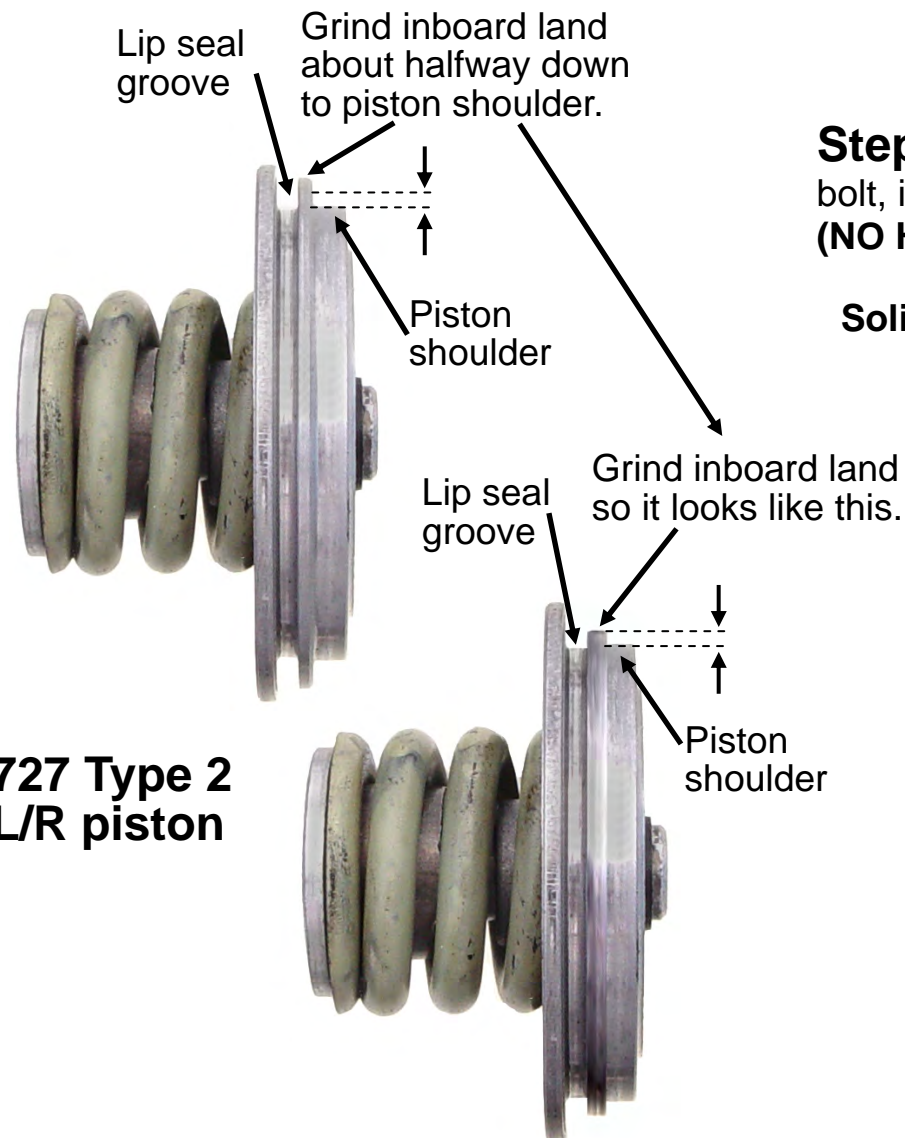

727 Type 2 L/R piston

**Adjust rear band**  
Tighten snug with short wrench.  
Single wrap band: Back off 2 1/2 turns.  
Double wrap band: Back off 3 1/2 turns  
[Double wrap band has three sections across]  
Tighten the locknut.

**Front band adjustment:**  
Tighten snug with short wrench.  
Back off 2 turns and tighten nut.  
Adjustment on outside of case.



Mr Shift



# Lock Up Transmission Issue

If you have to use a Lock-up Transmission and this product setup for Full Manual Control this is our only solution. **There will be no lockup function.** The problem is there is no easy way to control lock-up separately from the rest of the 3 gears you control with the shift selector. That's why officially we don't support this products use within a lockup transmission. Ok, now stop kicking your heels. Here's what you can do as an unofficial work-around.

## Step 1)

**DO NOT** use a torque converter with a clutch in it. Order a "Test Torque" converter from your converter supply company. They will build you one without a clutch in it.

## Step 2)

Disassemble your lock-up body and install a **rubber** 1/4" checkball inside the spring as shown below. When you tighten the side plate the ball will block the valve from shifting. Re-assemble the valve body. You're done! Please do not call us for any other advise concerning this product if you are trying to use a torque converter **with** a clutch. Thank you.

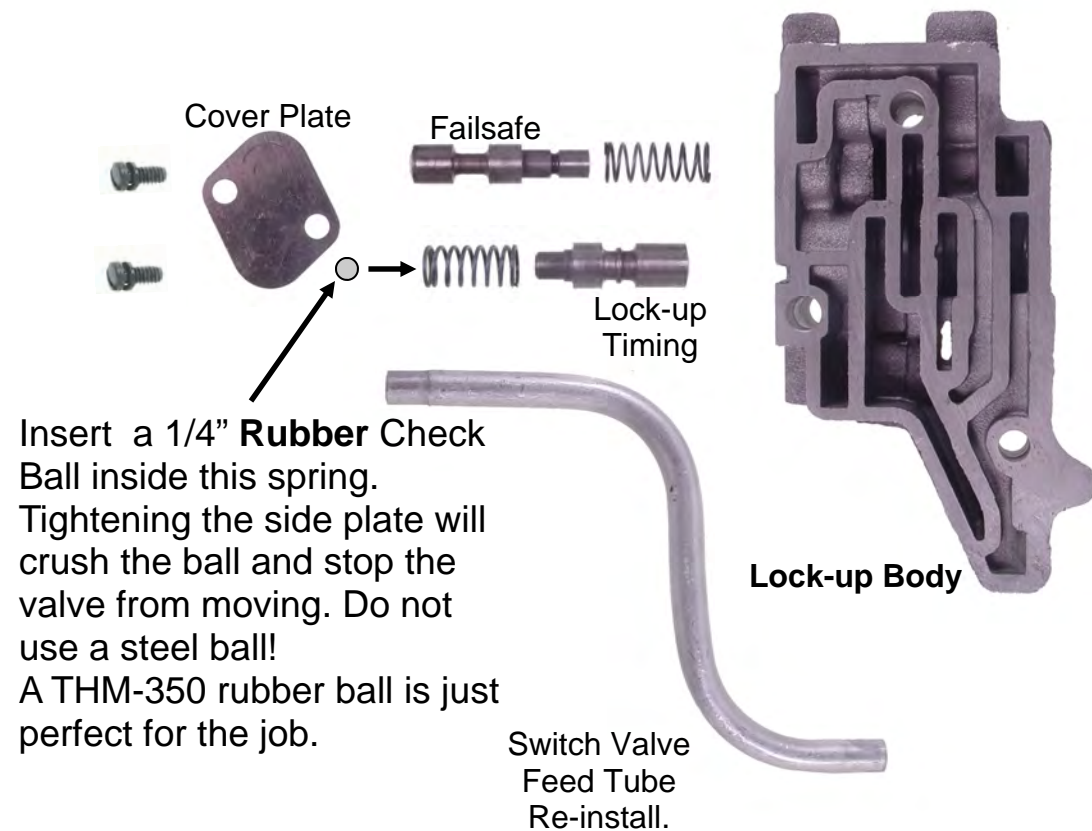

# Converting Back For Automatic Shifts.

